

# Installation manual

Montageanleitung • Notice de montage • Istruzioni per il montaggio  
Manual de montaje • Monteringsanvisning • Installatiegids • Asennusohje • Installationsmanual

## Element house EL16-3524

Elementhaus • Maison à modules • Casetta in elementi • Cobertizo • Redskapsbod • Element huis • Elementti piharakennus • Friggebod

Width 348 x Depth 239 cm



Breite/Tiefe • Largeur/Profondeur • Lunghezza/Profondità • Ancho/Profundidad • Bredde/Dybde • Breedte/Diepte • Leveys/Pituus • Bredd/Längd







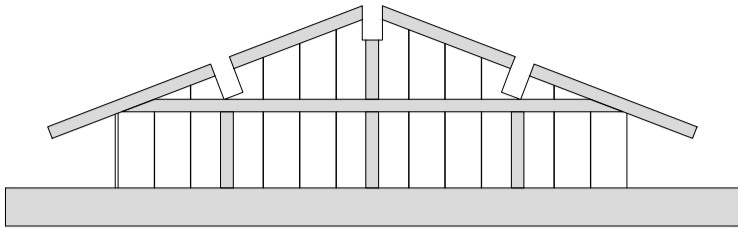
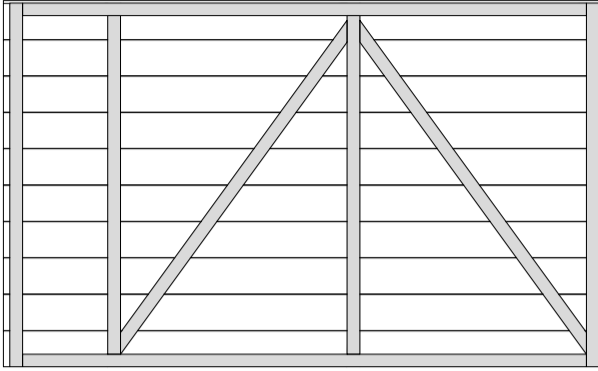
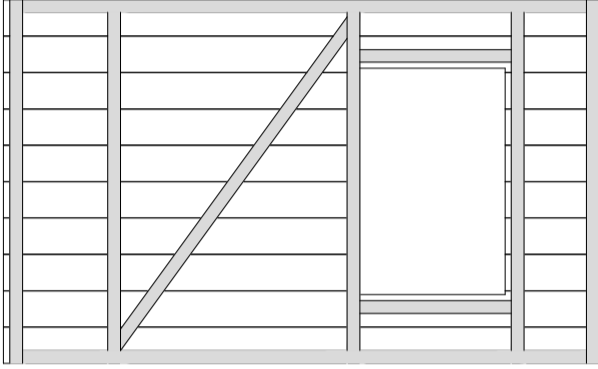
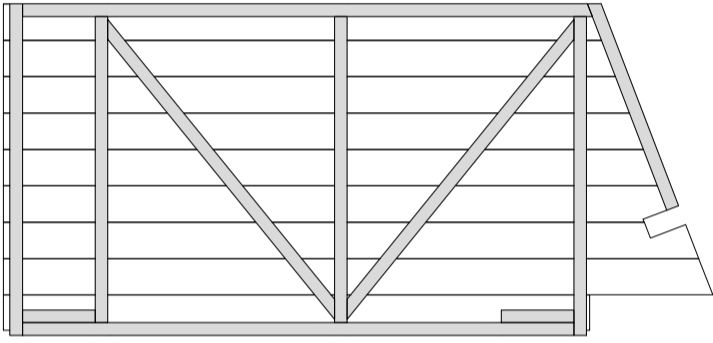
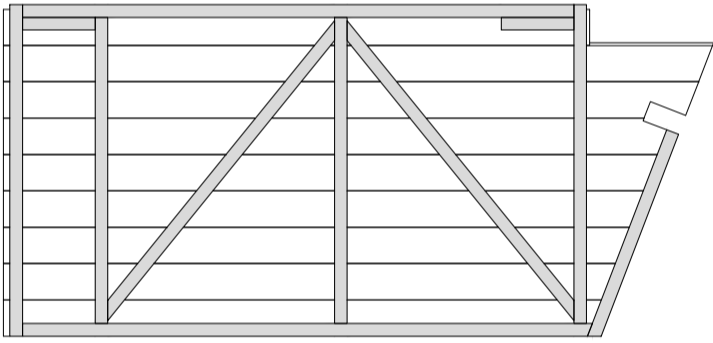
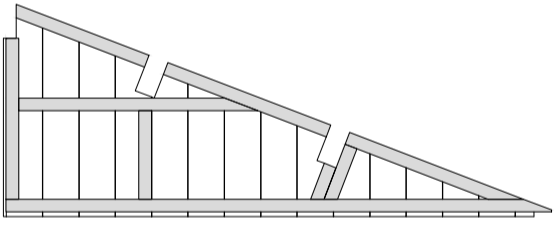
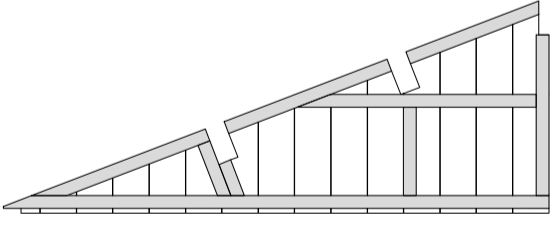
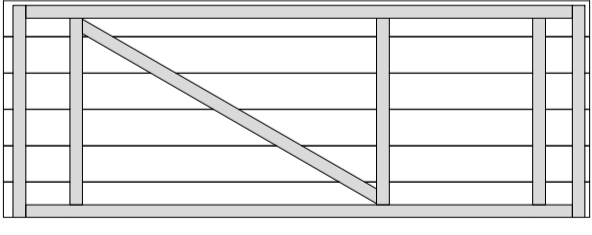
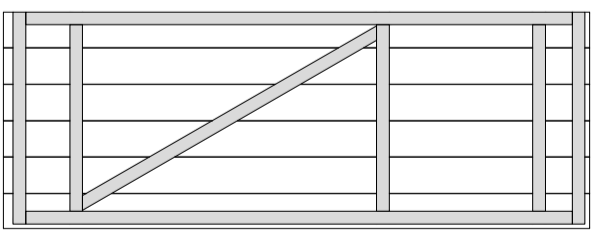
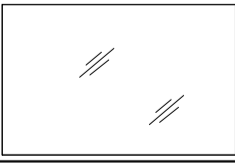
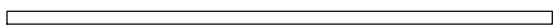

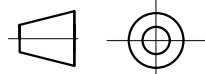

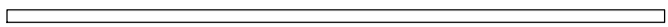
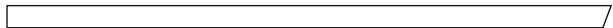





Log thickness 16 mm

Bohlenstärke • Épaisseur des murs • Spessore delle pareti • Grosor de pared • Tykkelse • Wanddicke • Seinän paksuus • Väggtjocklek



The producer shall have the right to make technical changes to the product • Technische Änderungen vorbehalten • Le producteur réserve le droit d'effectuer des modifications techniques au produit • Il produttore mantiene il diritto di apportare modifiche tecniche al prodotto • Reservado el derecho a modificaciones técnicas • Produsent forbeholder seg retten til å endre tekniske egenskaper ved produktet • Alle rechten en technische wijzigingen voorbehouden • Valmistaja pidättää oikeuden tehdä tuotteeseen teknisiä muutoksia • Tillverkaren har rätt att utföra tekniska förändringar för produkten

Pos	SPECIFICATION-STÜCKLISTE-NOMENCLATURE-ELEMENTI-ESPECIFICACIÓN EL16-3524		Pcs	Profile (mm)	Length (mm)
Wel-1	Wall element- Wandelement- Panneau du mur- Elemento di muro- Elemento pared		1	48x2320	696
Wel-2	Wall element- Wandelement- Panneau du mur- Elemento di muro- Elemento pared		8	48x1158	1884
Wel-3	Wall element- Wandelement- Panneau du mur- Elemento di muro- Elemento pared		1	48x1158	1884
Wel-4	Wall element- Wandelement- Panneau du mur- Elemento di muro- Elemento pared		1	48x1048	2243
Wel-5	Wall element- Wandelement- Panneau du mur- Elemento di muro- Elemento pared		1	48x1048	2243
Wel-6	Wall element- Wandelement- Panneau du mur- Elemento di muro- Elemento pared		1	48x1725	671
Wel-7	Wall element- Wandelement- Panneau du mur- Elemento di muro- Elemento pared		1	48x1725	671
Del-1	Door element- Türelement- Panneau du porte- Elemento di porta- Elemento puerta		1	48x685	1854
Del-2	Door element- Türelement- Panneau du porte- Elemento di porta- Elemento puerta		1	48x685	1854
PG1	 Plexiglass- Plexiglas- Plexiglas- Plexiglas- Plexiglas			750x1.5	475
AR1	 Foundation- Fundament- Fondation- Fondazione- Vigas de cimentación		12	32x40	1725
AR2	 Foundation- Fundament- Fondation- Fondazione- Vigas de cimentación		6	32x40	400
 Object name EL16-3524				Page 1/3	

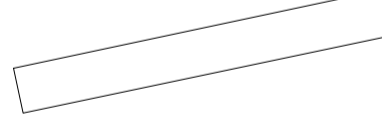
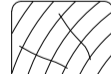
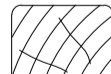
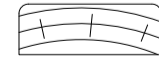
Pos	SPECIFICATION-STÜCKLISTE-NOMENCLATURE-ELEMENTI-ESPECIFICACIÓN EL16-3524			Pcs	Profile (mm)	Length (mm)
CnB1	Connecting board- Verbindungsbrett- Madrier de connection- Tavola di collegamento- Listón de juntura 			2	32x40	2080
CoB2	Covering board- Deckbrett- Madrier de couverture- Tavola di copertura- Listón de cubierta 			4	70x19	1911
CoB1	Covering board- Deckbrett- Madrier de couverture- Tavola di copertura- Listón de cubierta 			4	70x19	1764
Sis2	Side slat- Randleiste- Baguette en bordure- Listón de borde- Listello bordo 			2	19x19	754
Sis1	Side slat- Randleiste- Baguette en bordure- Listón de borde- Listello bordo 			2	19x19	441
Sla1	Slat- Leiste- Baguette- Listello- Listón 			2	45x16	907
Sla2	Slat- Leiste- Baguette- Listello- Listón 			1	19x27	716
Sla4	Slat- Leiste- Baguette- Listello- Listón 			2	12x40	796
Sla3	Slat- Leiste- Baguette- Listello- Listón 			2	12x40	540
PR5	Purlin- Dachpfette- Arbalétrier- Arcareccio- Correa 			2	32x120	2300
PR2	Purlin- Dachpfette- Arbalétrier- Arcareccio- Correa 			8	32x120	2300
PR4	Purlin- Dachpfette- Arbalétrier- Arcareccio- Correa 			2	32x120	550
PR3	Purlin- Dachpfette- Arbalétrier- Arcareccio- Correa 			8	32x120	550
PR1	Purlin- Dachpfette- Arbalétrier- Arcareccio- Correa 			4	28x120	1425
RB1-1	Roof board- Dachbrett- Madrier du toit- Tavola tetto- Tabla de tejado		66	89x16	2080	
FB1-1	Floor board- Fussbodenbrett- Madrier du plancher - Tavola pavimento- Tabla de suelo		39	89x16	2364	
WP1	Wall panelling- Wandverkleidung- Revetement du mur- Rivestimento di muro- Revestimiento de pared		2	114x16	1884	
EaE1-1	Eave edging- Dachrandbrett- Madrier en bordure du toit- Tavola bordo tetto- Tabla de valadizo		4	16x95	1425	
FaB3-1	Facia board- Giebelblende- Écran frontal- Schermo frontone- Tabla de facia		4	16x120	2120	
RE2-1	Roof edge reinforcement- Dachrandleiste- Baguette en bordure du toit- Rinforzo bordo tetto- Refuerzo borde tejado		2	32x40	950	
RE2-2	Roof edge reinforcement- Dachrandleiste- Baguette en bordure du toit- Rinforzo bordo tetto- Refuerzo borde tejado		2	32x40	1900	
WB1-1	Wind brace- Windbrett- Madrier contre le vent- Tavola vento- Tabla contra el viento		4	16x45	2120	

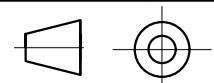



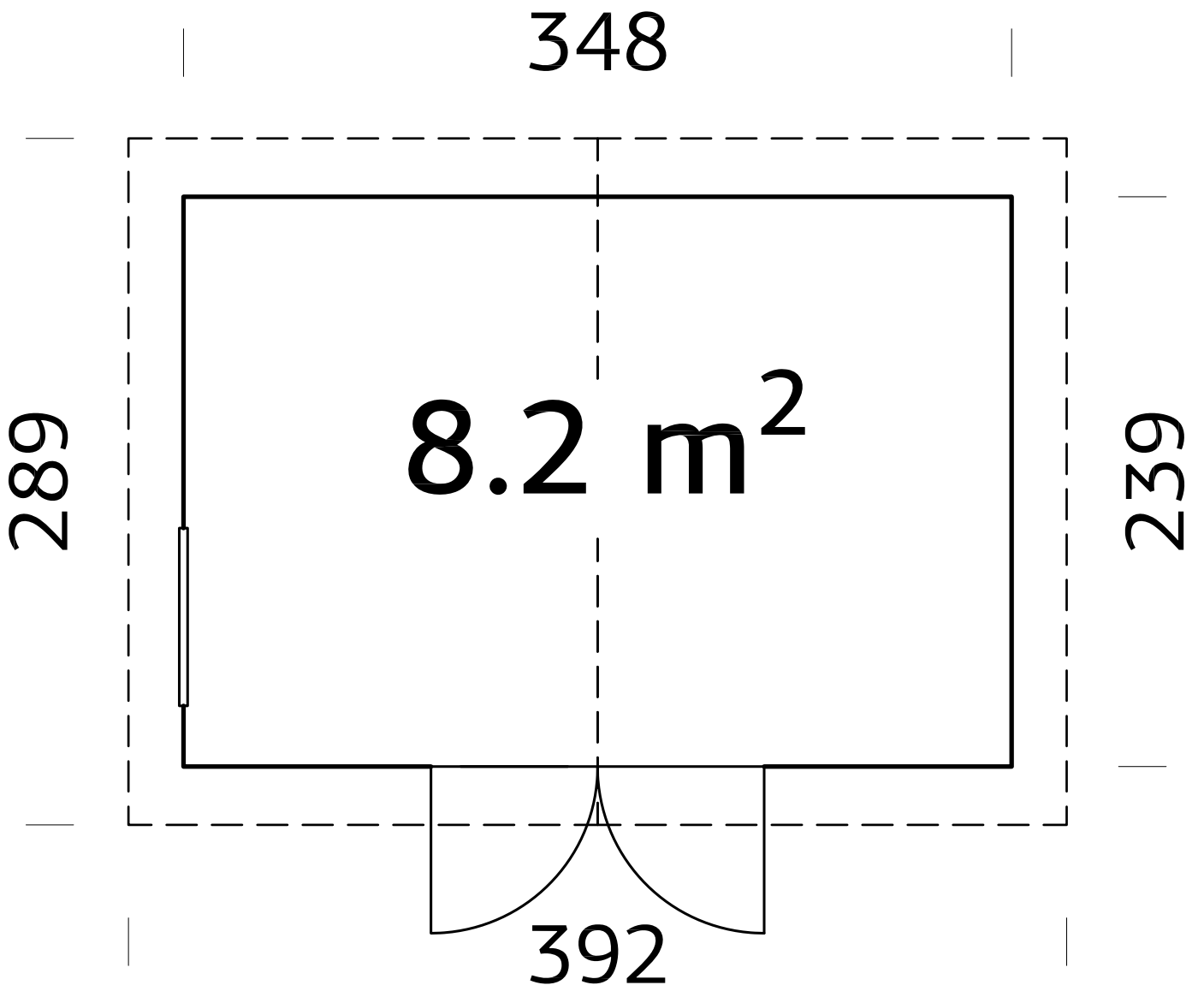

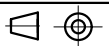
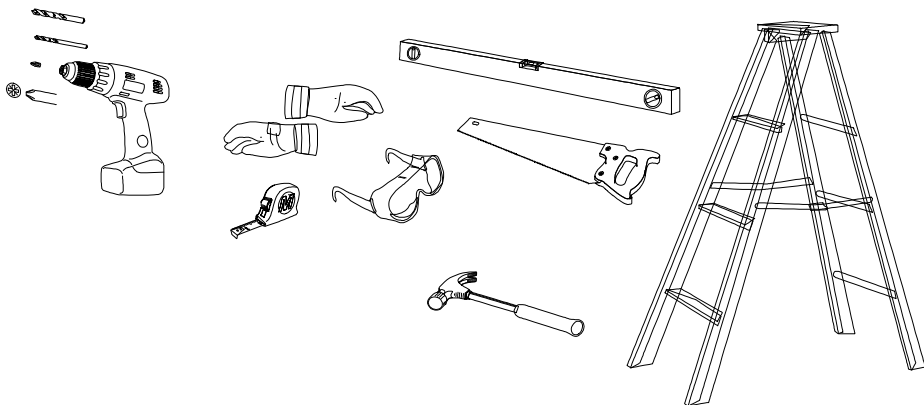
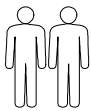
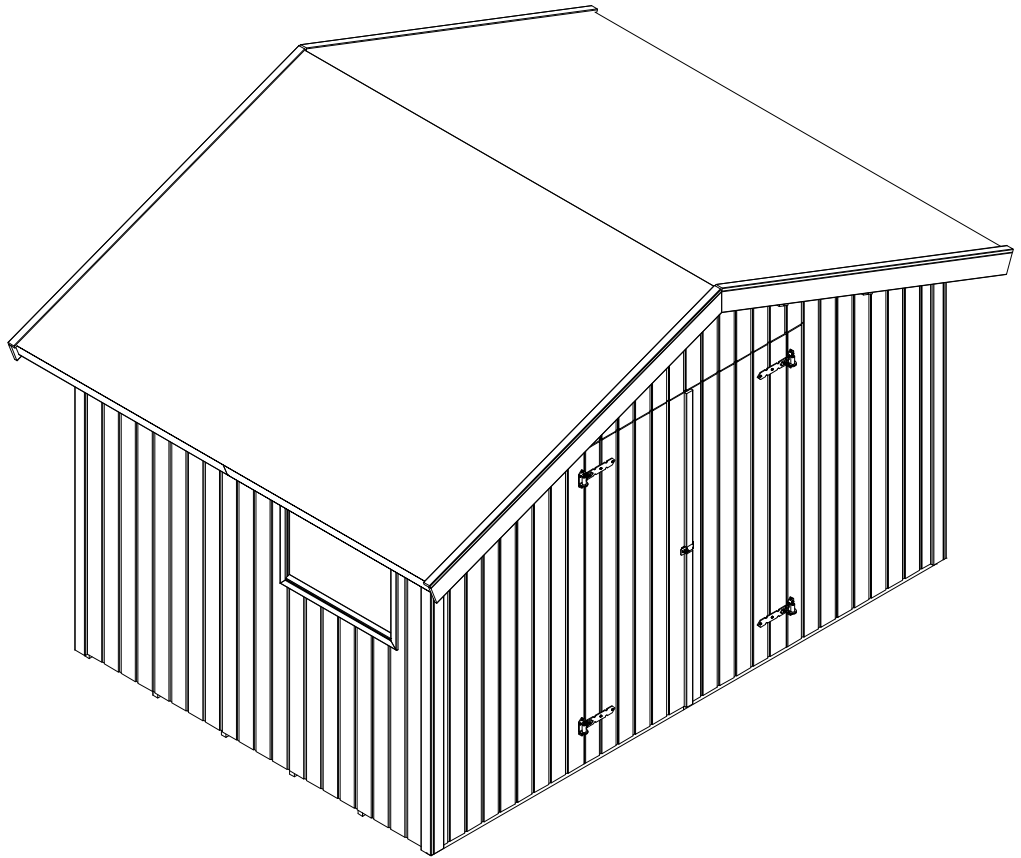

AR1 12 pcs  
 AR2 6 pcs  
 4,5x60 24 pcs

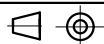
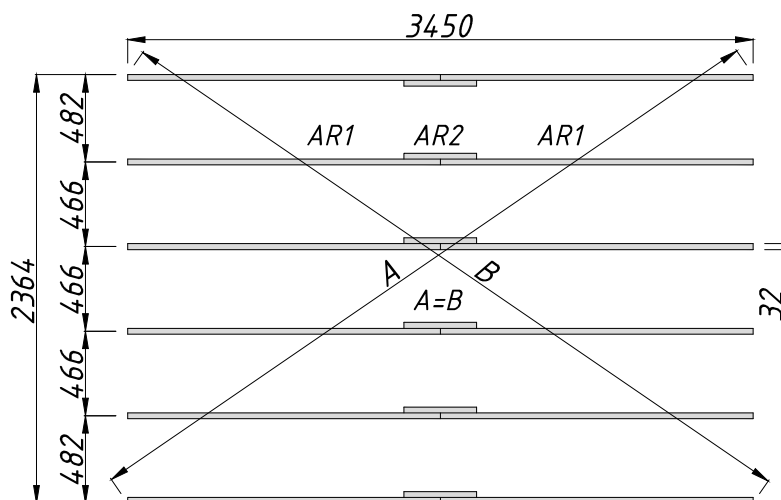
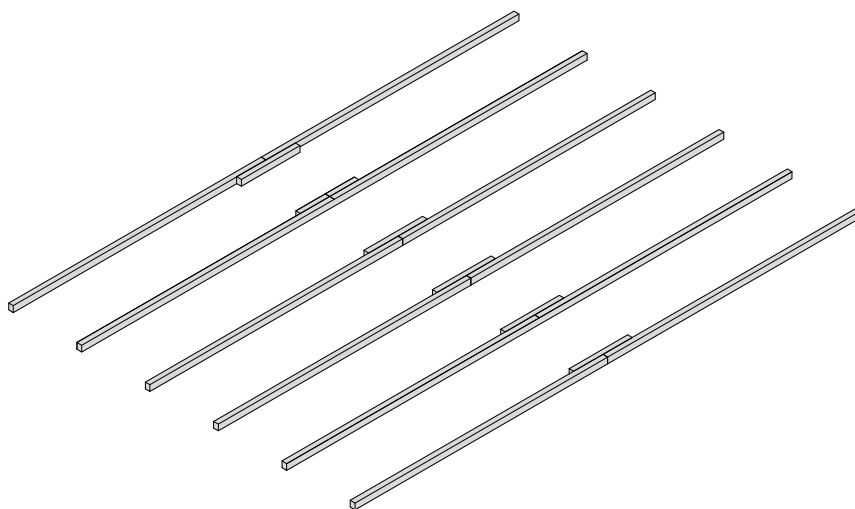
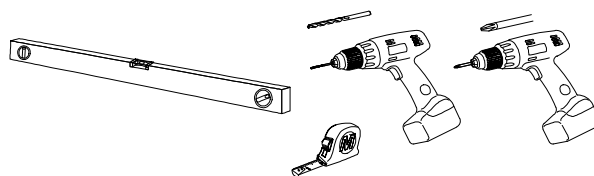
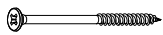

FB1-1  
2,5x50



39 pcs  
234 pcs

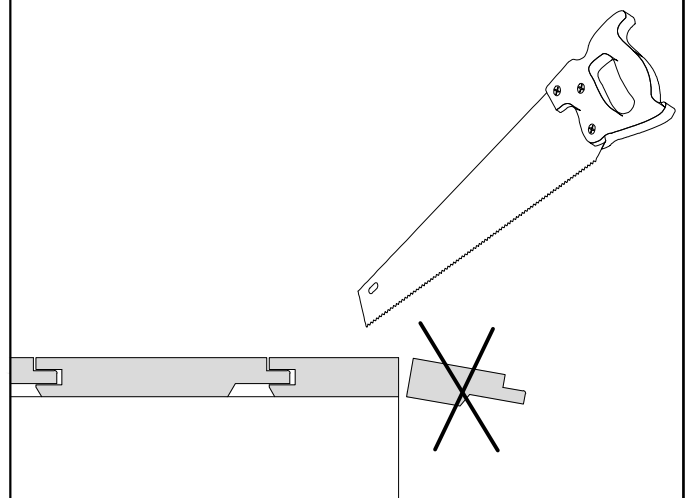
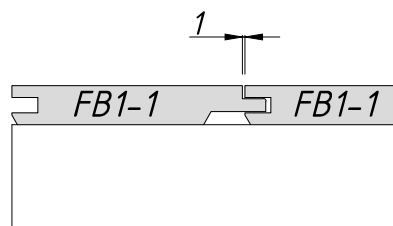
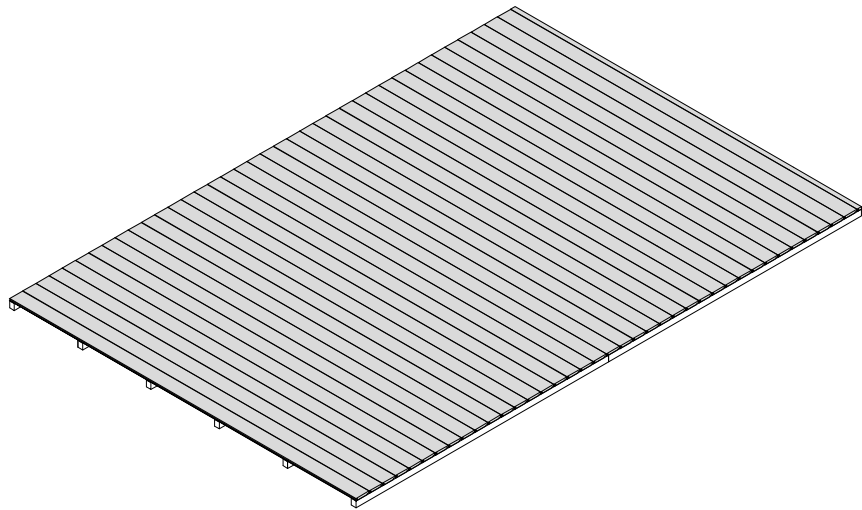
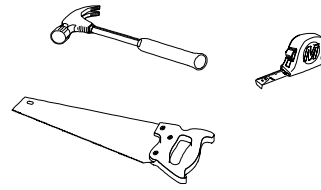



Wel-2  
4,5x70

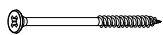

2 pcs  
10 pcs

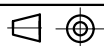
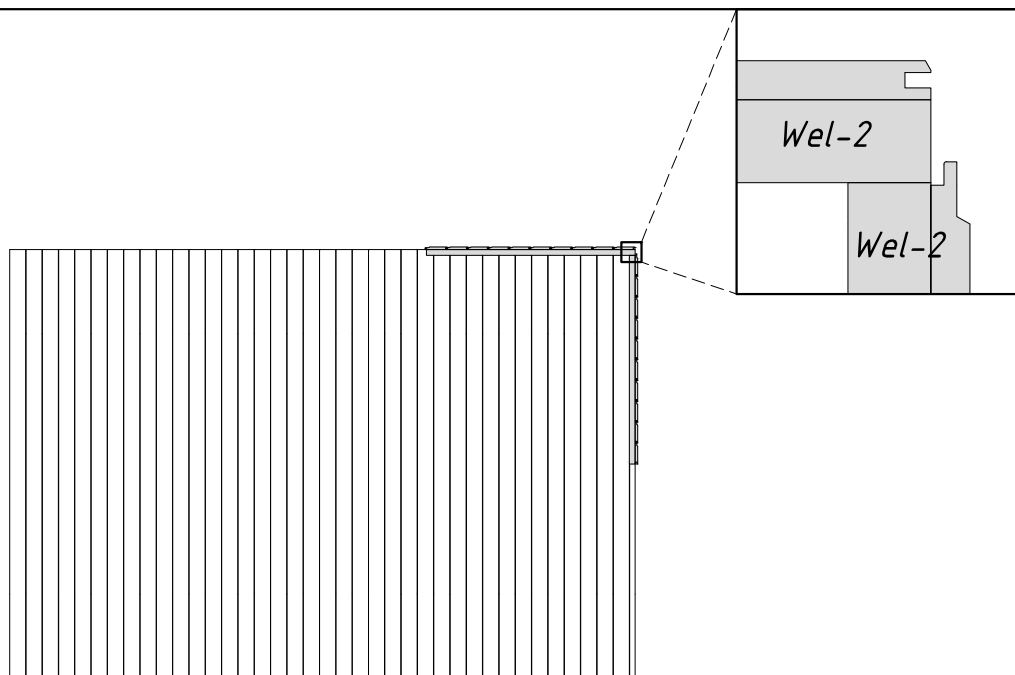
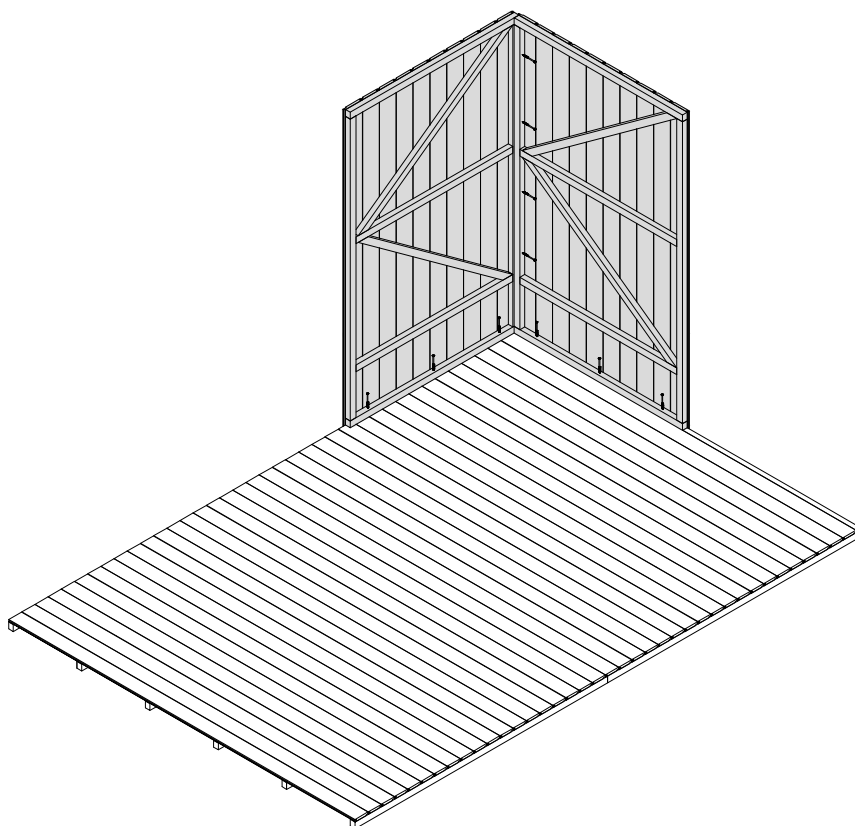
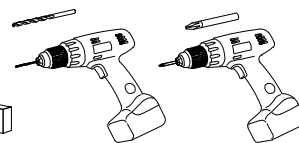
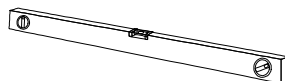

Wel-2  
CnB1  
4,5x70

2 pcs  
2 pcs  
18 pcs

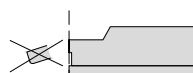
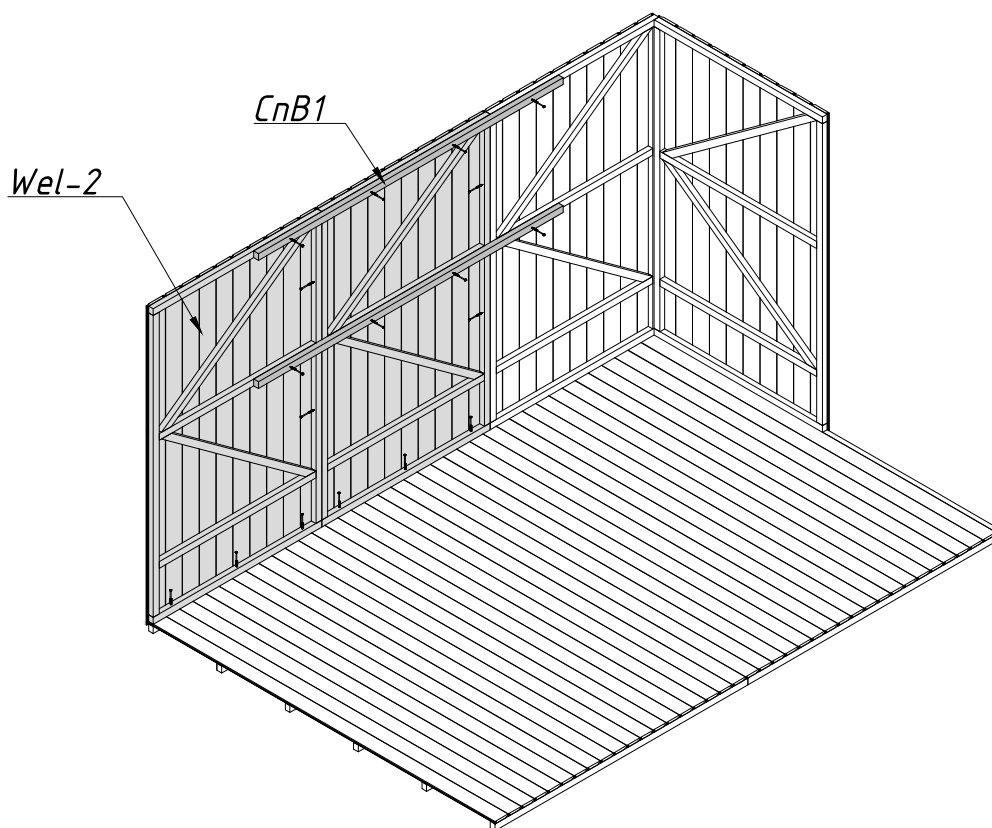
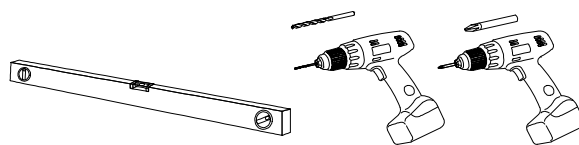
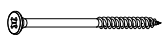



Wel-2

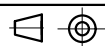
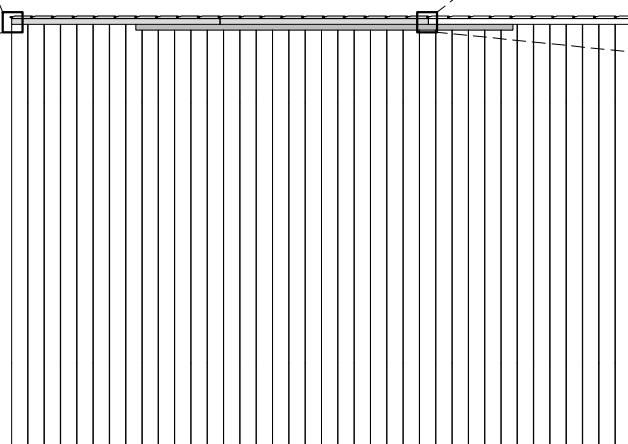
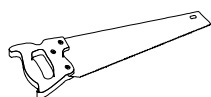

Wel-2

CnB1



<i>Wel-3</i>		1 pcs
<i>PG1</i>		1 pcs
<i>Sis1</i>		2 pcs
<i>Sis2</i>		2 pcs
<i>Sla2</i>		1 pcs
<i>Sla3</i>		2 pcs
<i>Sla4</i>		2 pcs
<i>1,4x40</i>		30 pcs

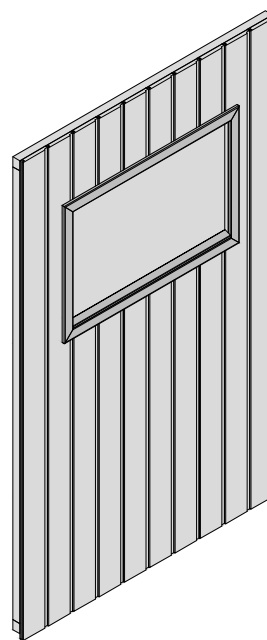
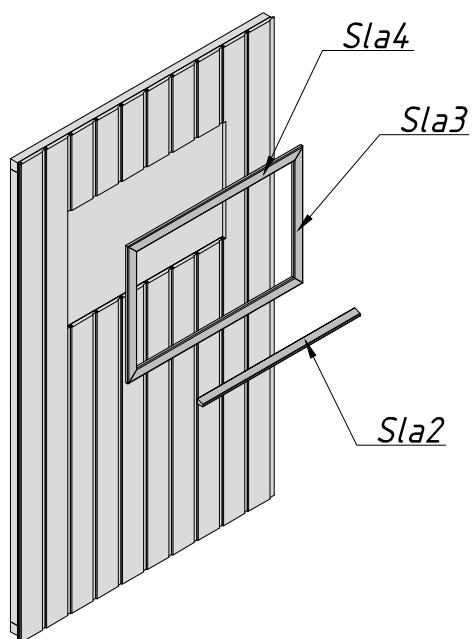
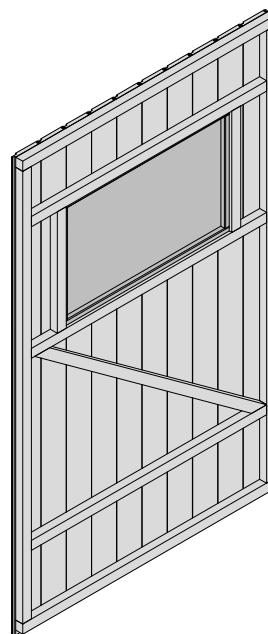
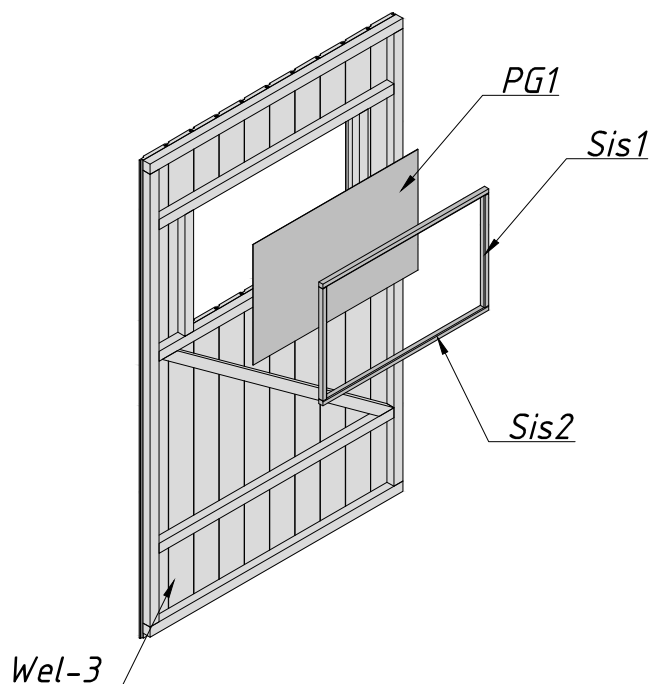
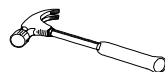

Wel-2  
Wel-3  
4,5x70

2 pcs  
1 pcs  
17 pcs

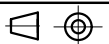
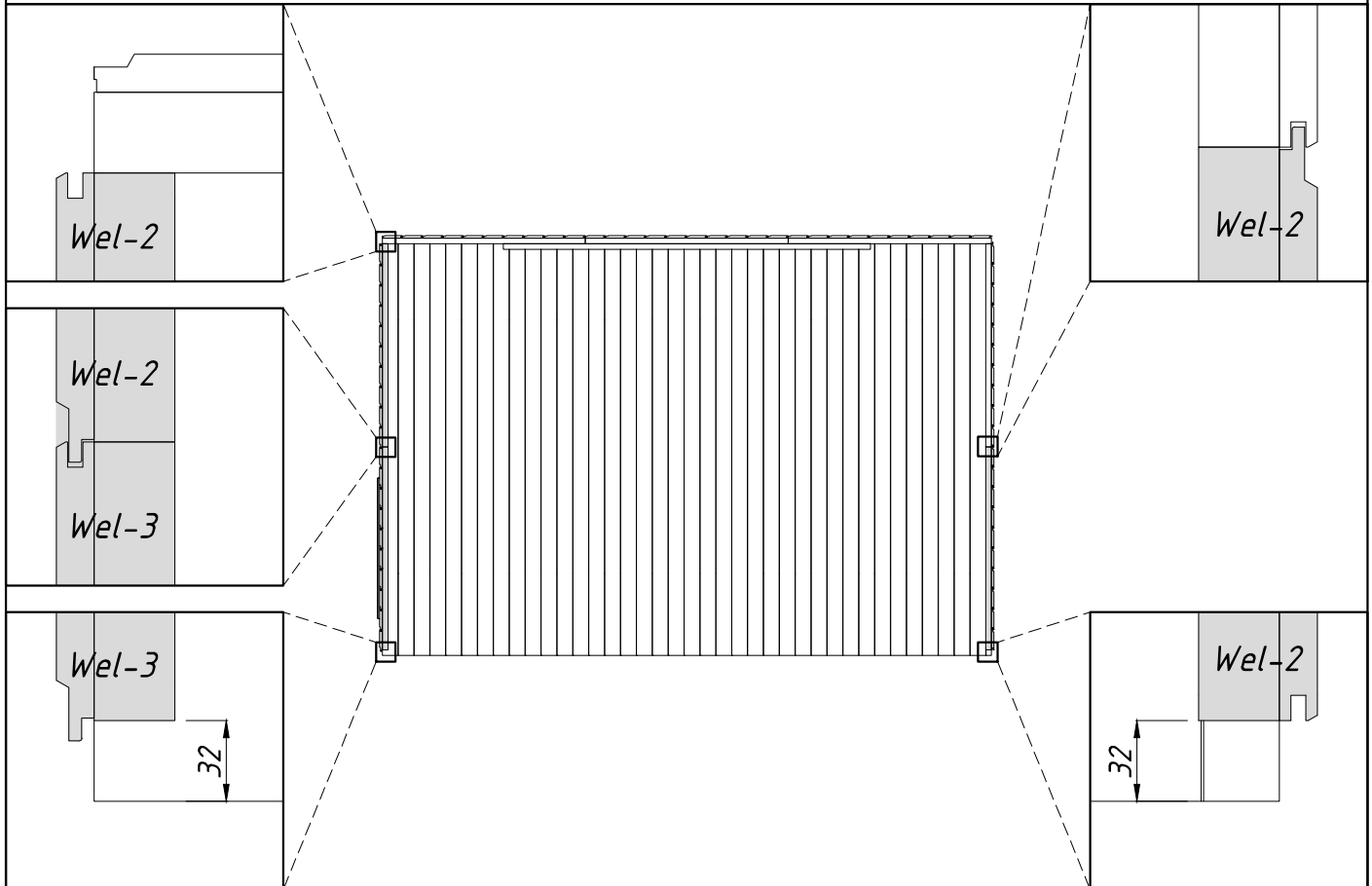
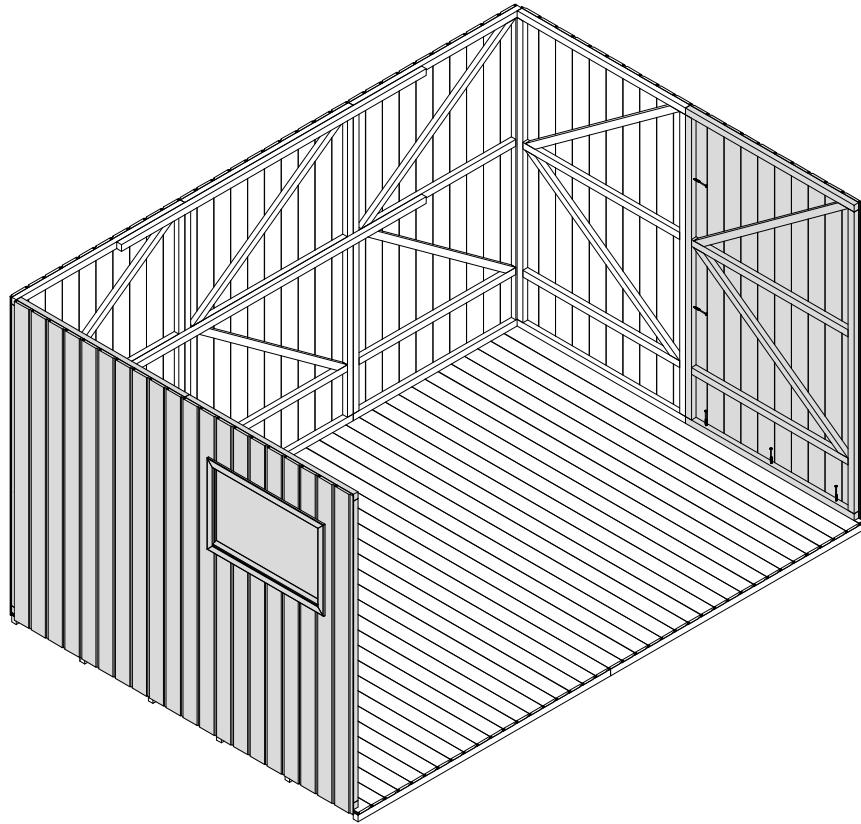
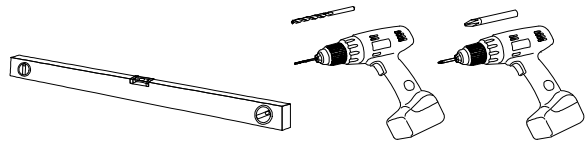

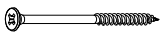
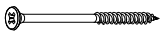
- Wel-1* 1 pcs
- Wel-4* 1 pcs
- Wel-5* 1 pcs
- 3,5x40  6 pcs
- 5x90  4 pcs

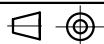
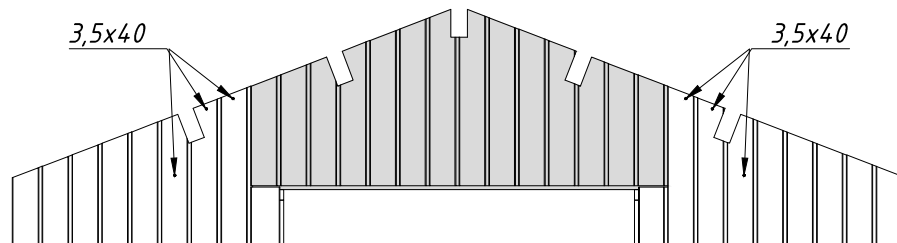
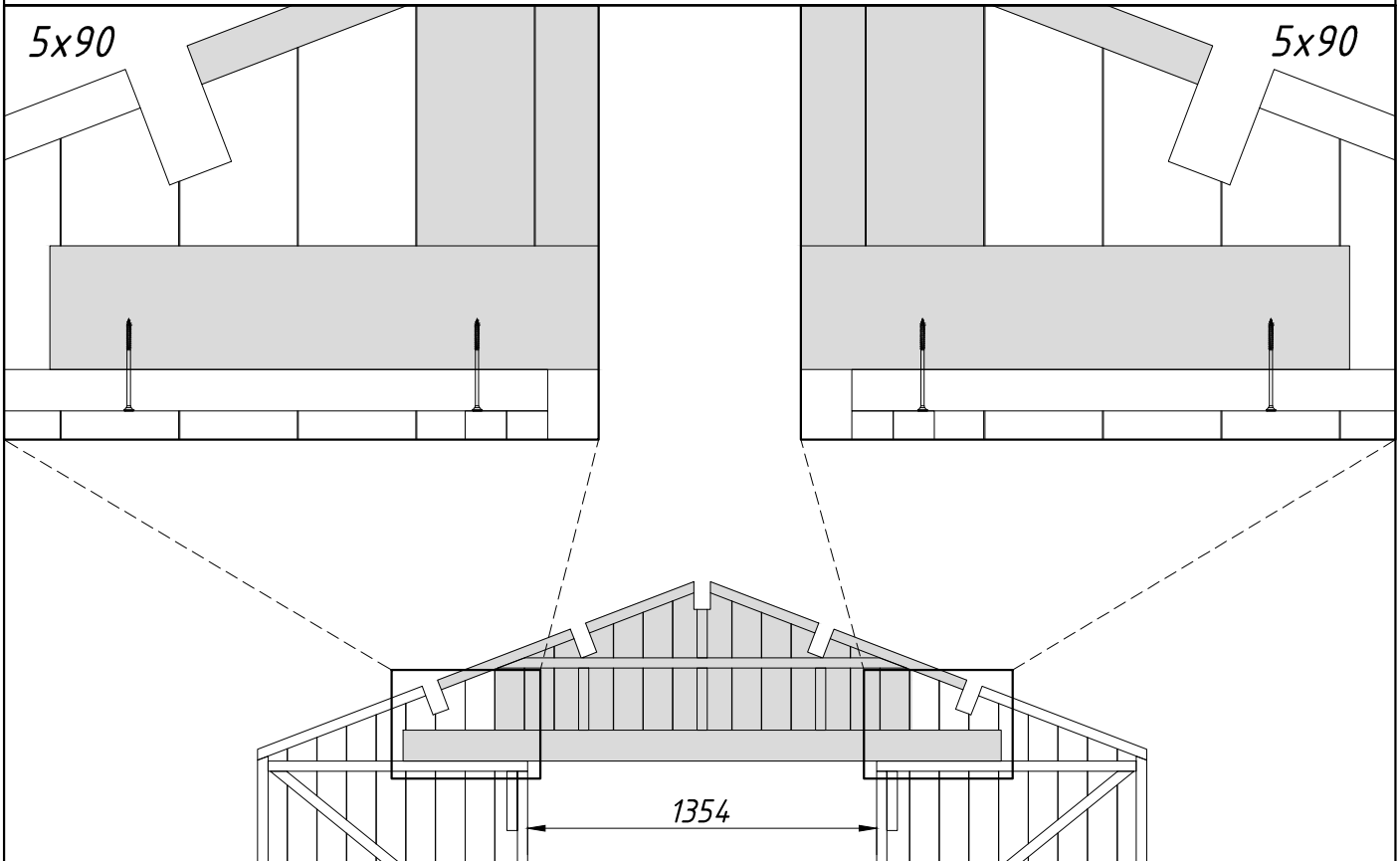
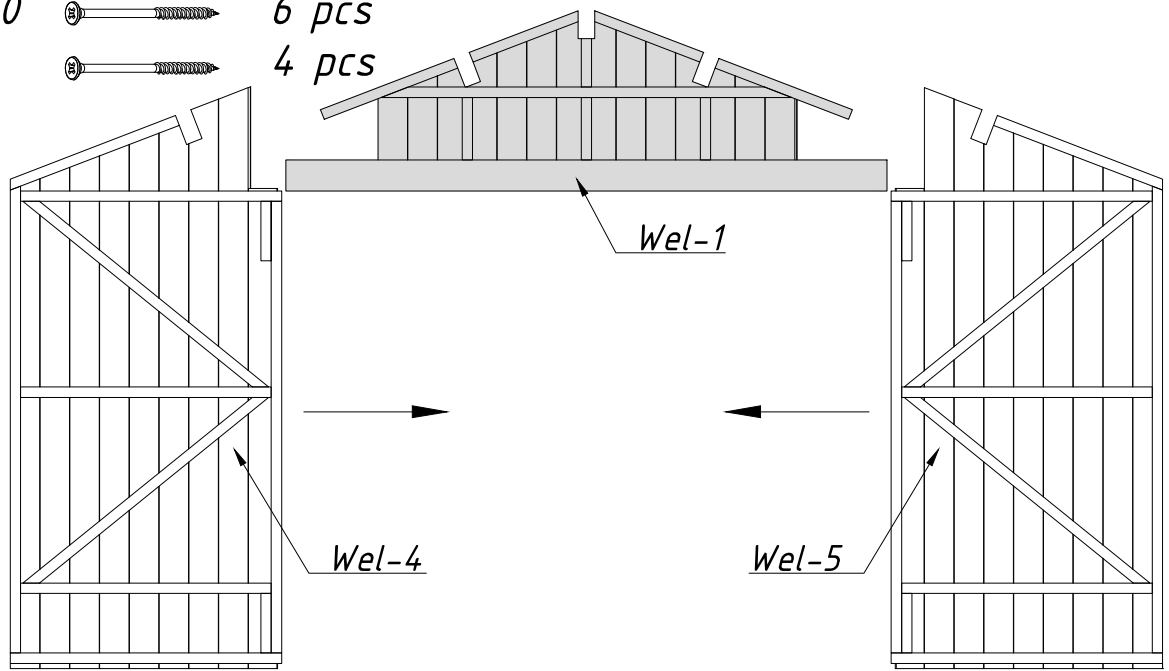
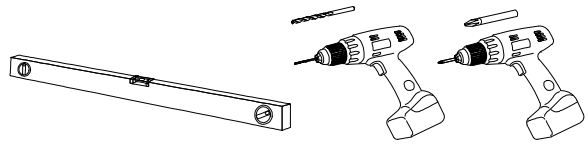

Wel-1/Wel-4/Wel-5

Wel-6 1 pcs

Wel-7 1 pcs

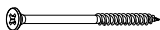
4,5x70  20 pcs

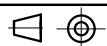
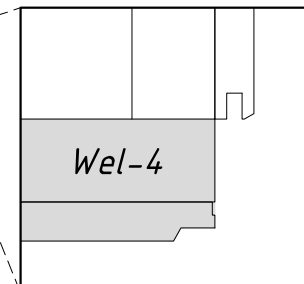
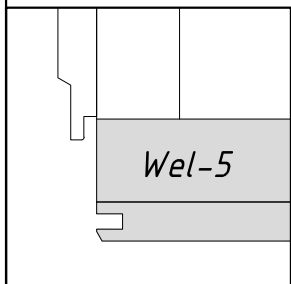
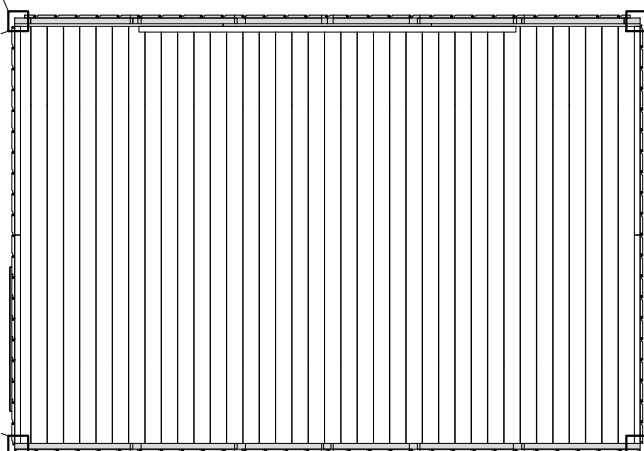
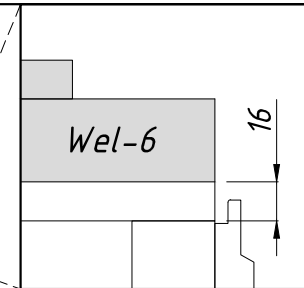
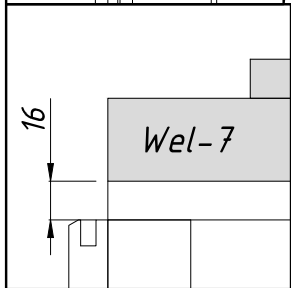
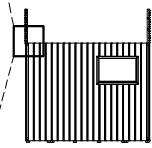
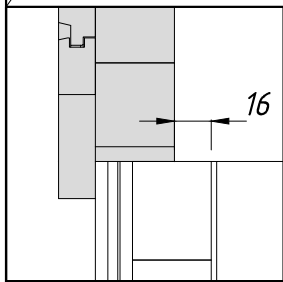
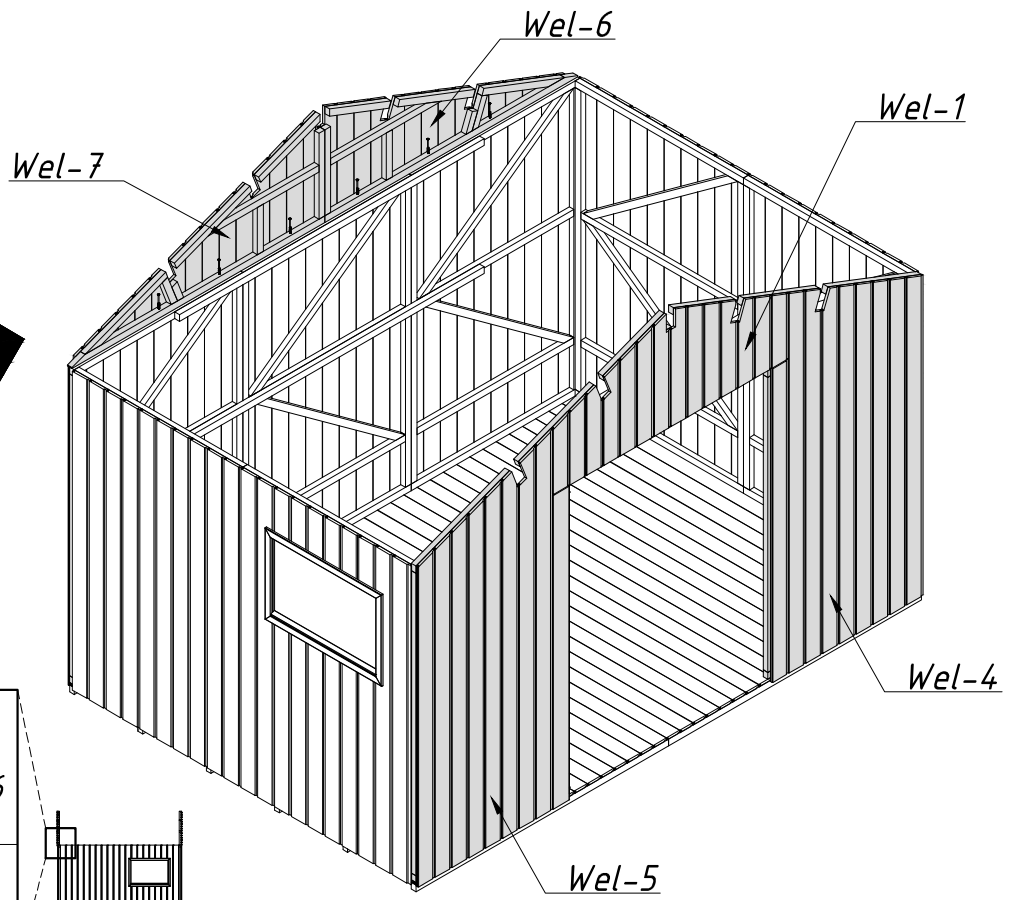
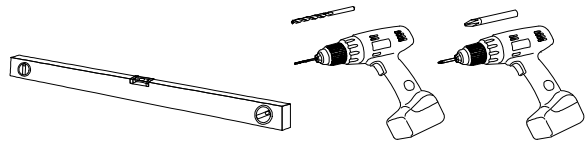

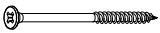
- PR2 8 pcs
- PR3 8 pcs
- PR4 2 pcs
- PR5 2 pcs
- 4,5x60  60 pcs

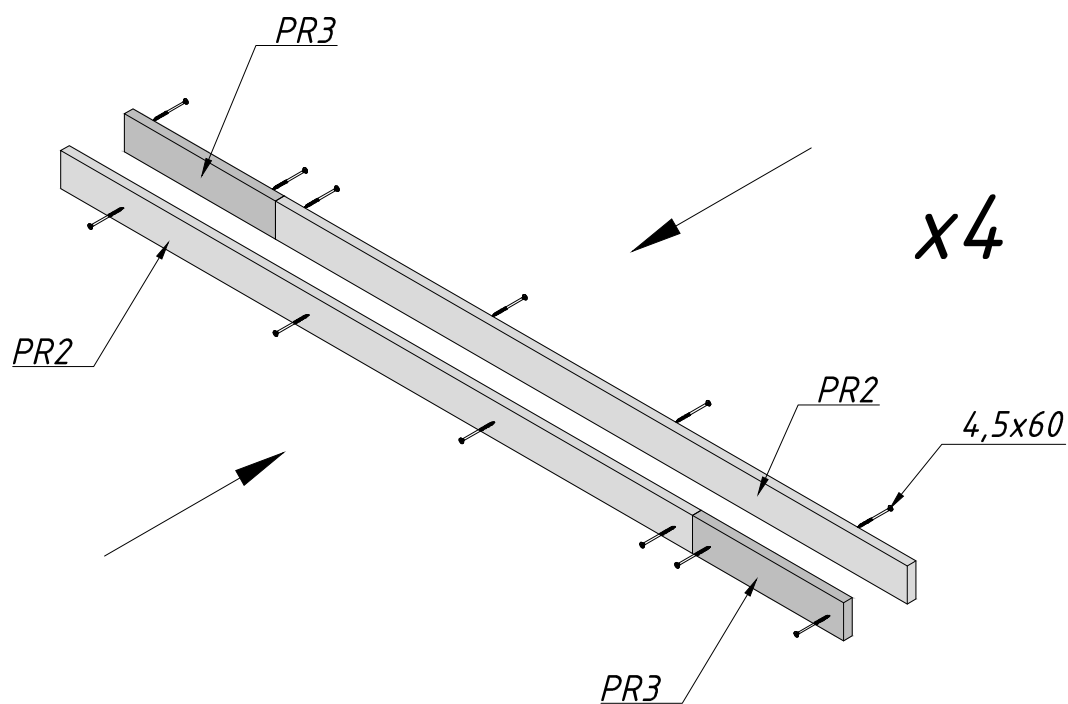
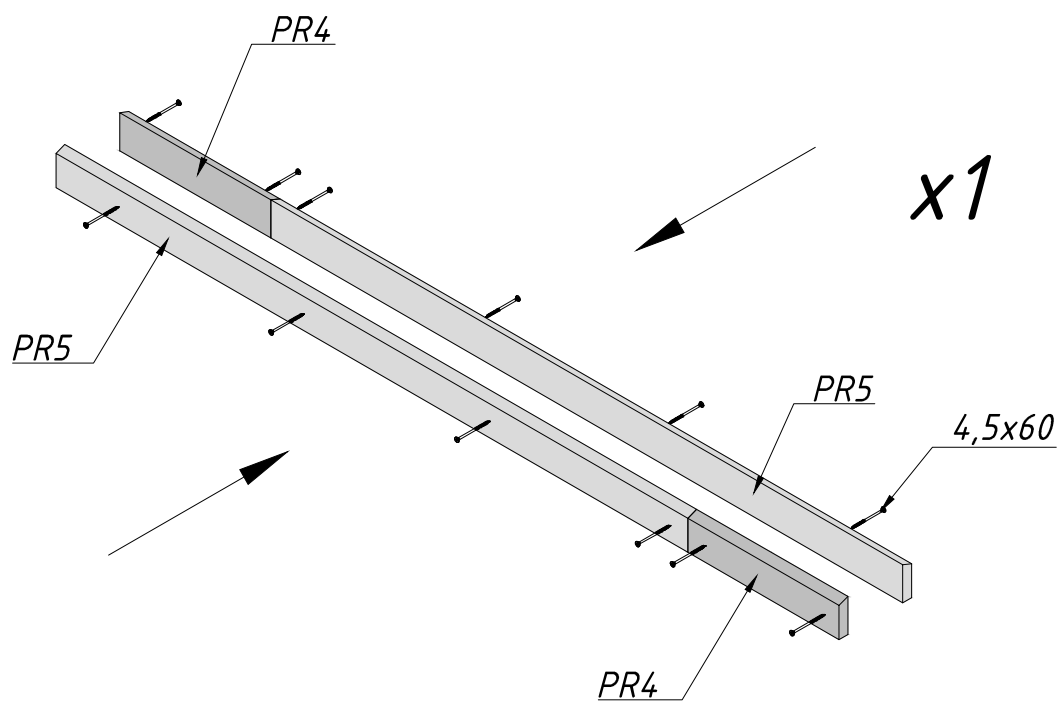
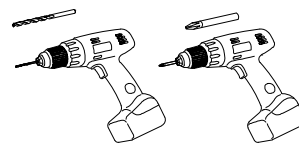

PR2/PR3 4 pcs  
 PR4/PR5 1 pcs  
 40x40x40 10 pcs  
 4,5x40 40 pcs

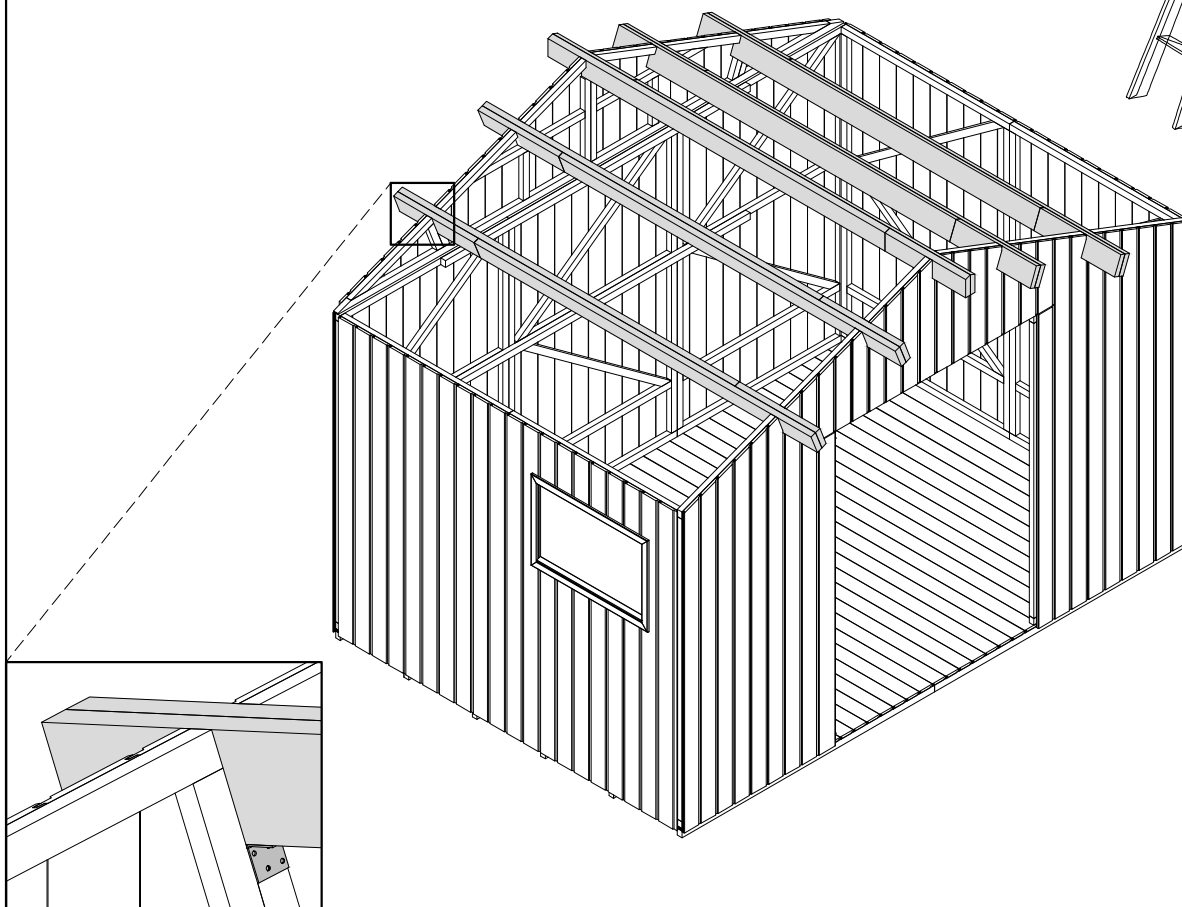
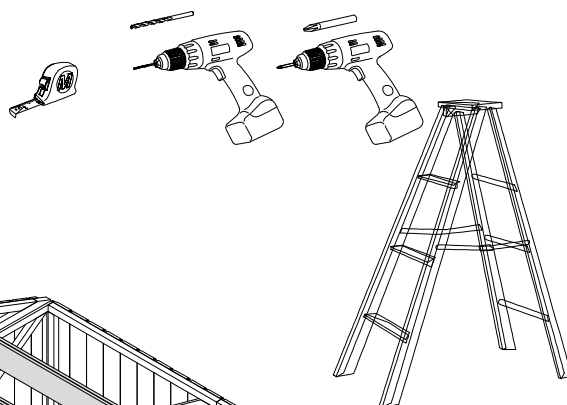
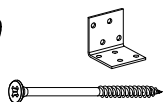

PR2/PR3

PR2/PR3

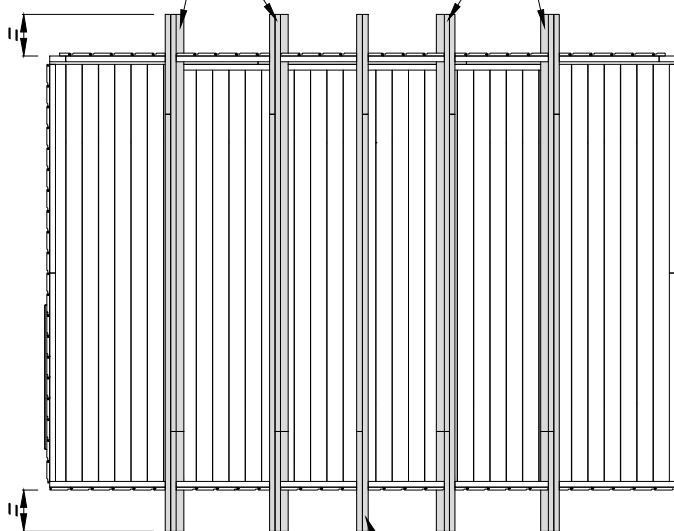

PR4/PR5

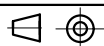



WP1  
3,5x40

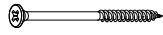

2 pcs  
24 pcs

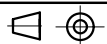
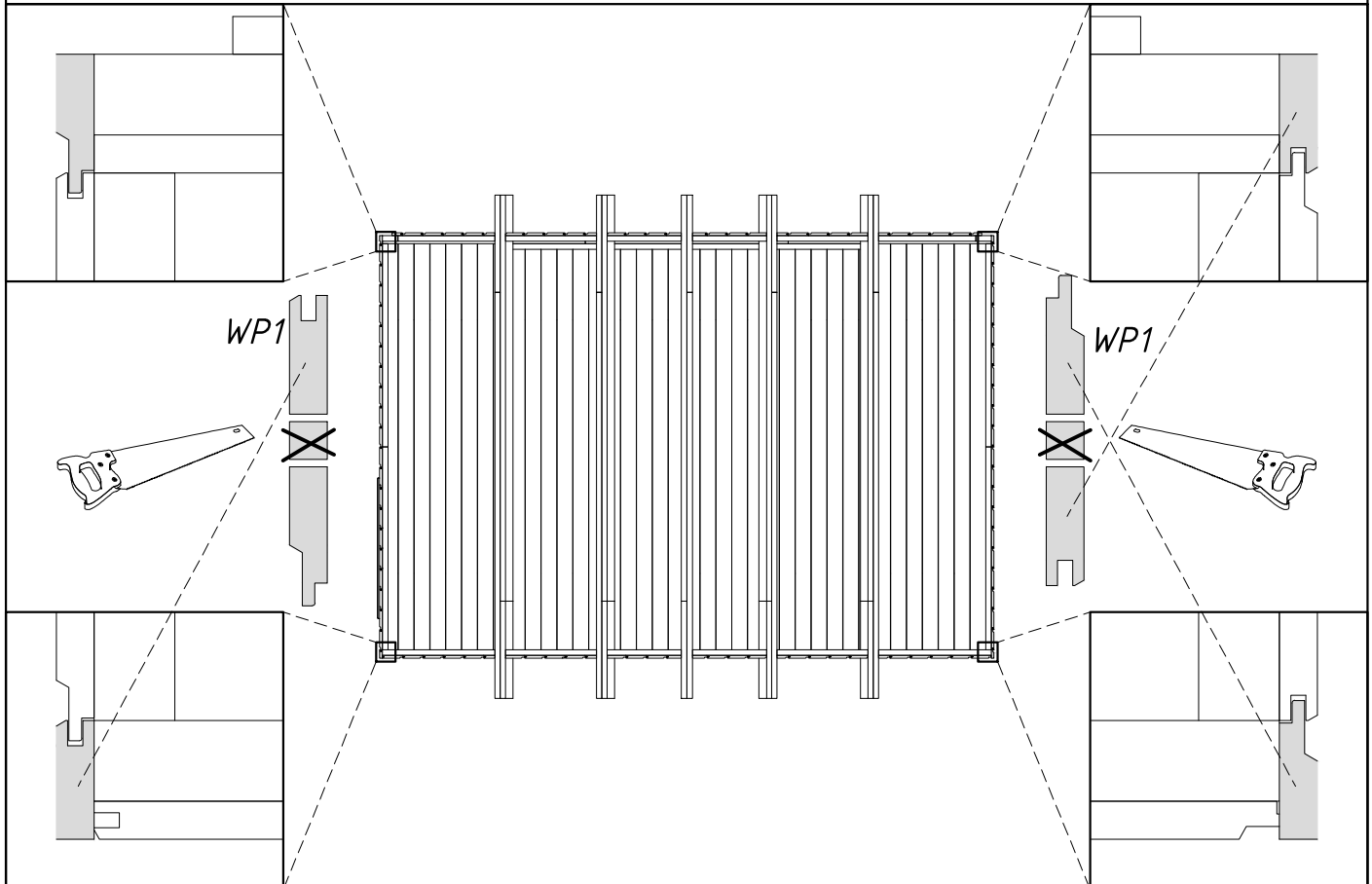
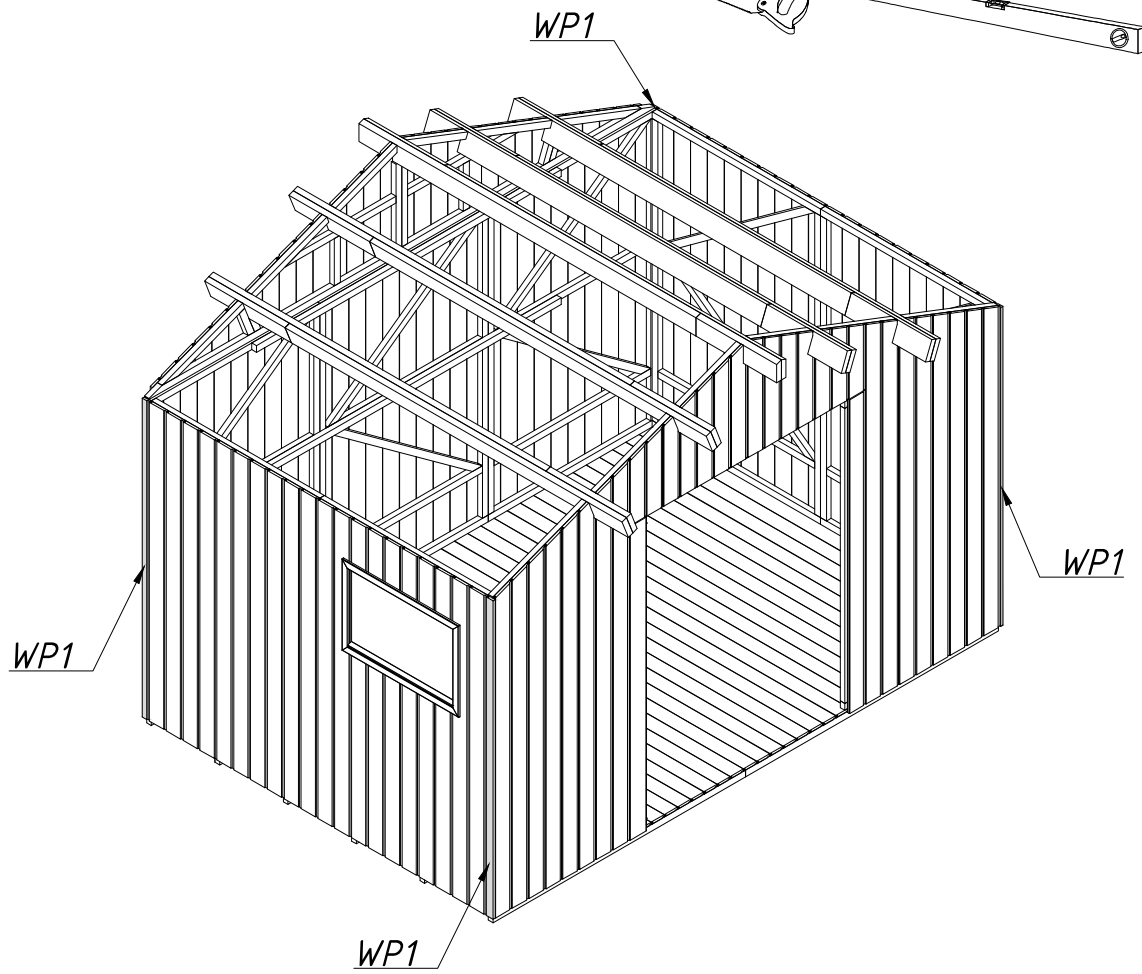
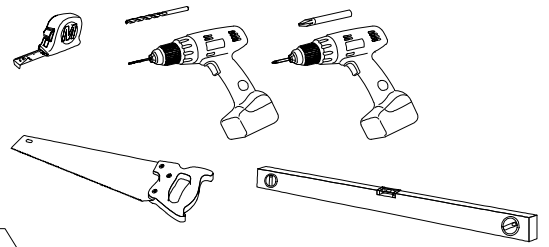

PR1  
4,5x70

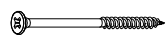

4 pcs  
16 pcs

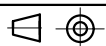
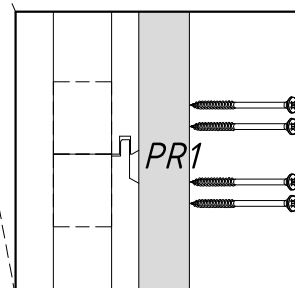
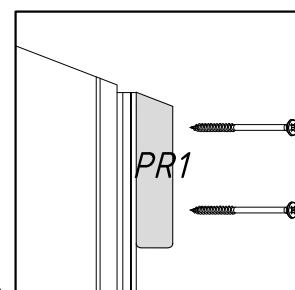
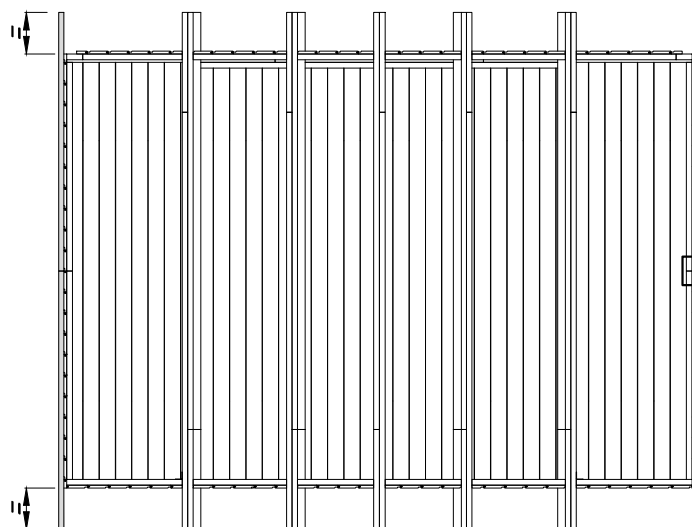
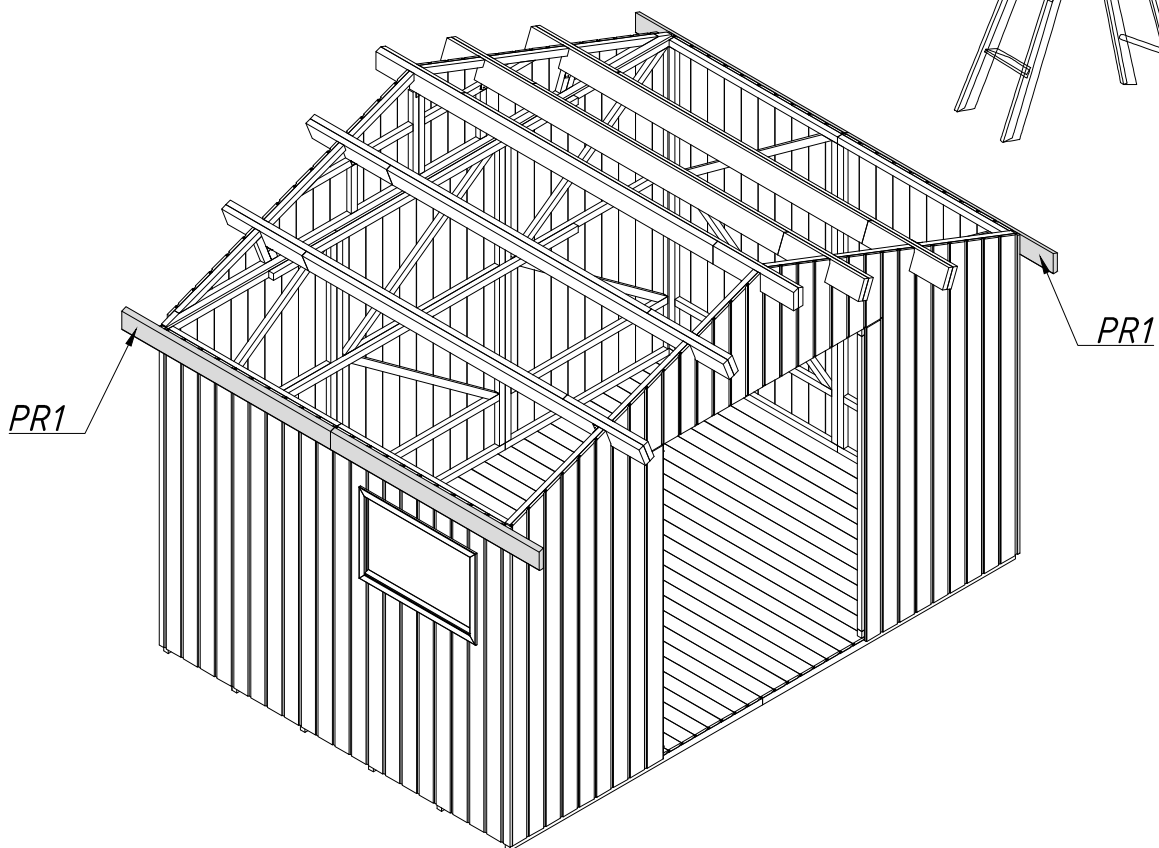
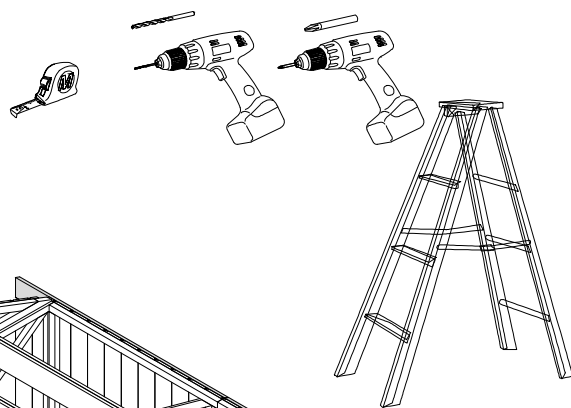

CoB1  
CoB2  
4,5x50



4 pcs  
4 pcs  
48 pcs

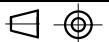
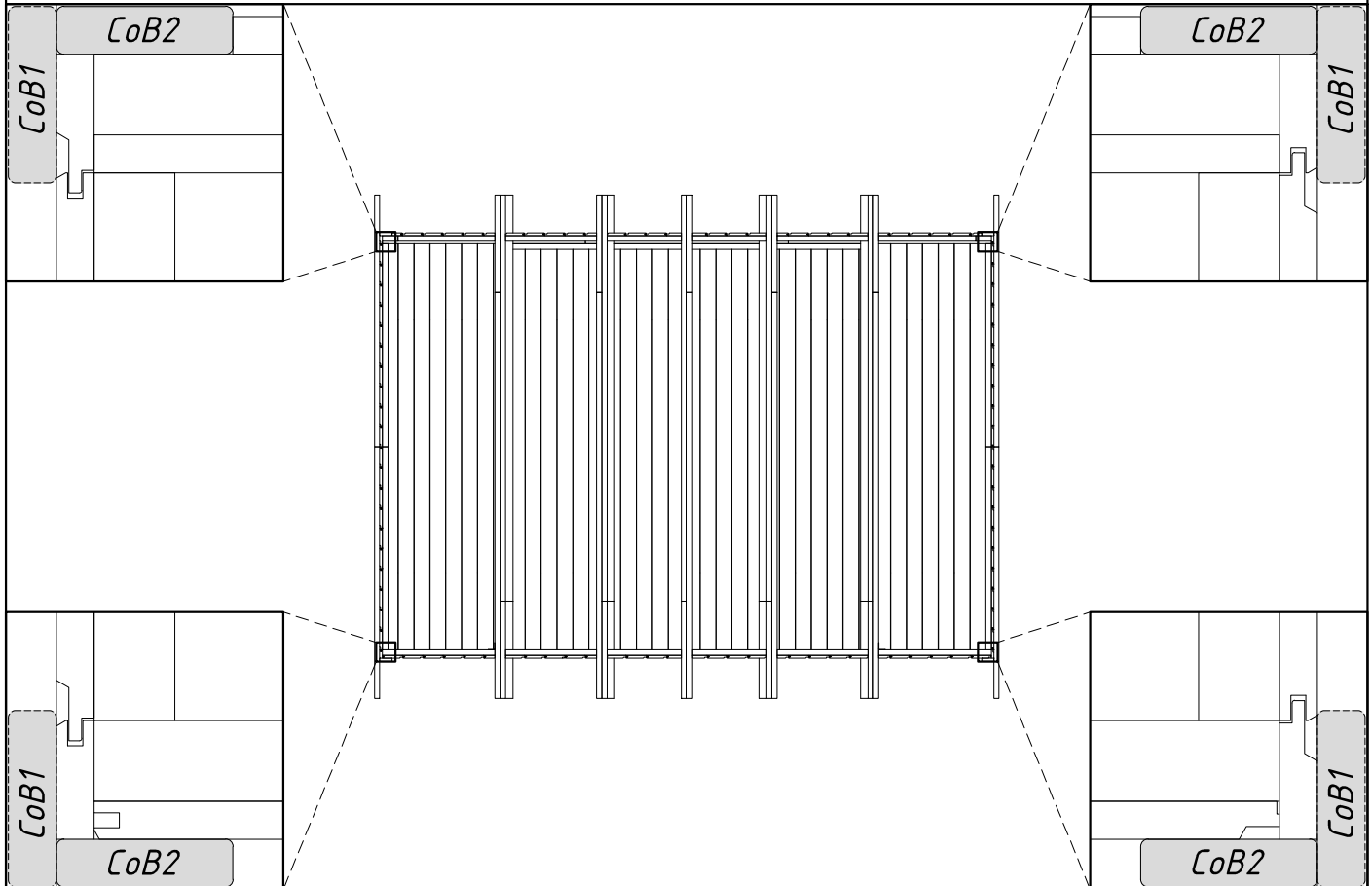
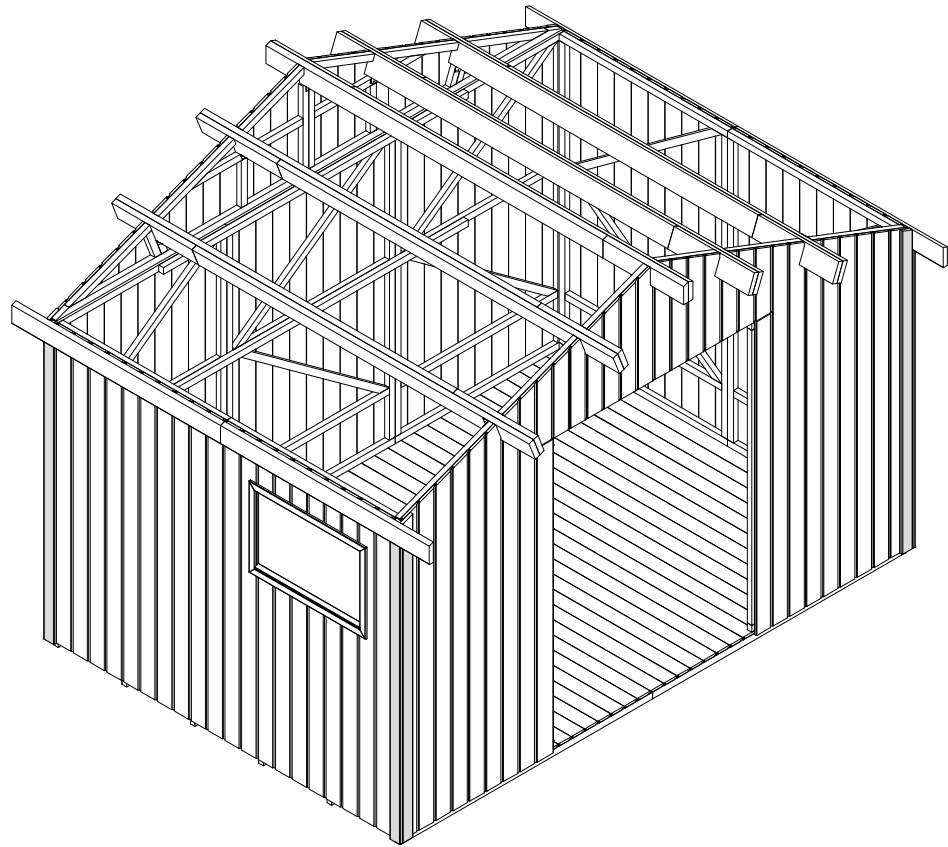
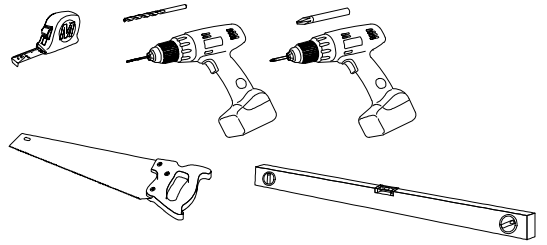

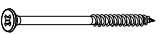
- RB1-1 66 pcs
- EaE1-1 4 pcs
- RE2-1 2 pcs
- RE2-2 2 pcs
- 2,5x50  270 pcs
- 3,5x40  26 pcs

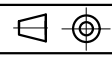
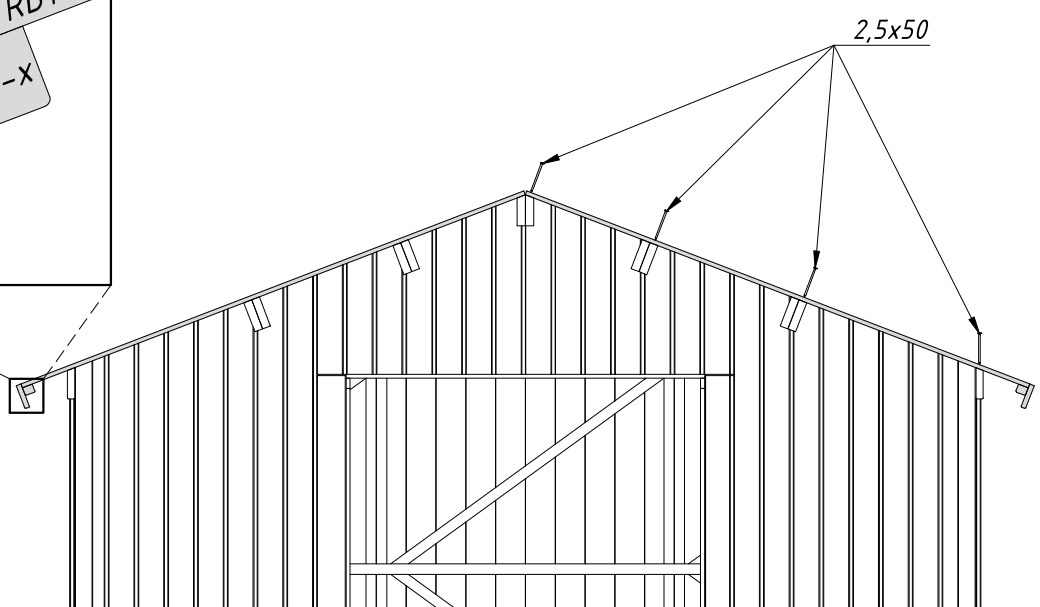
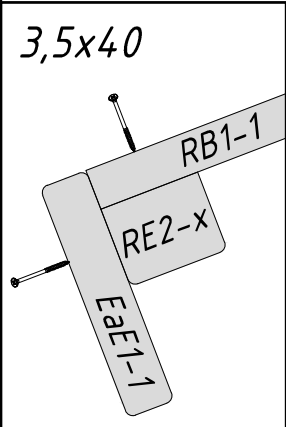
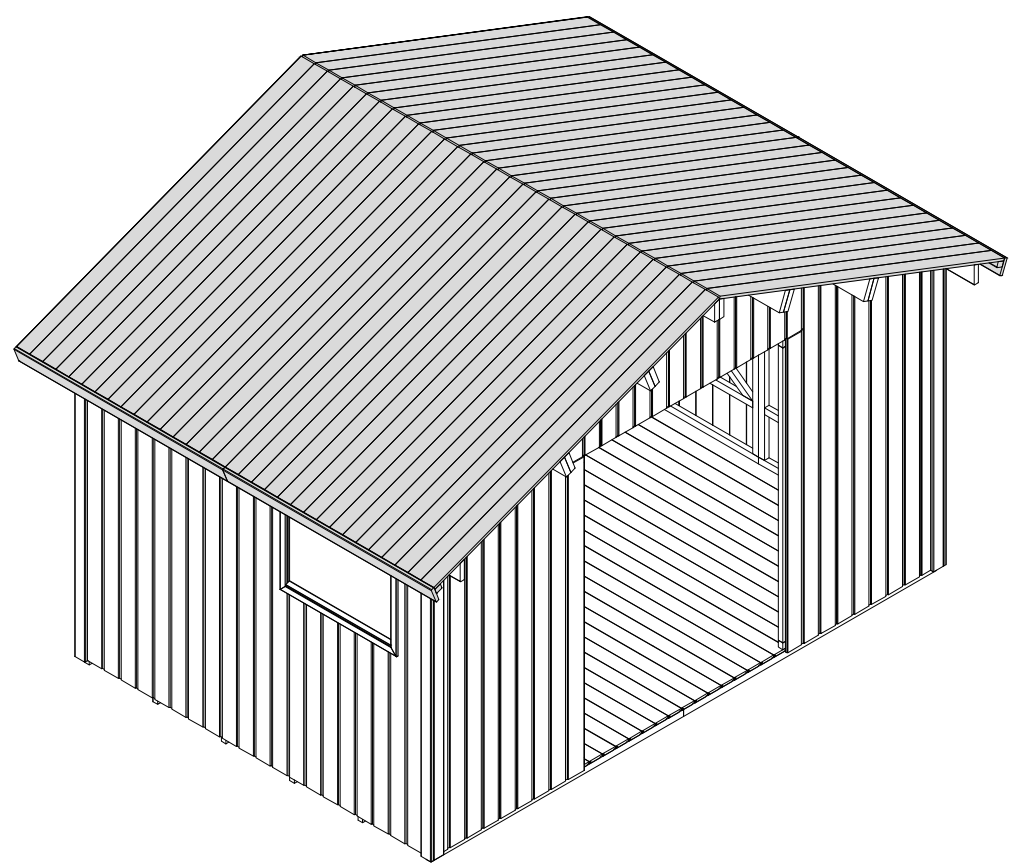
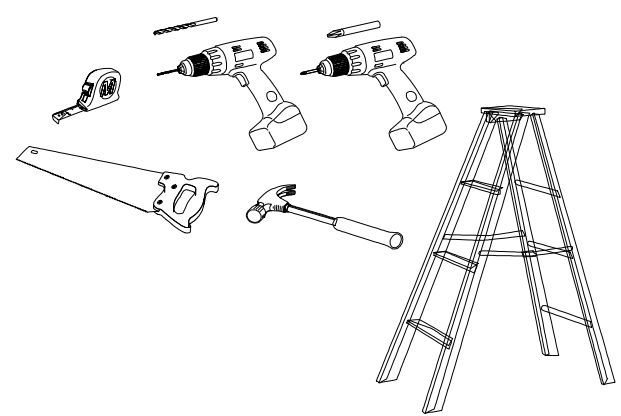

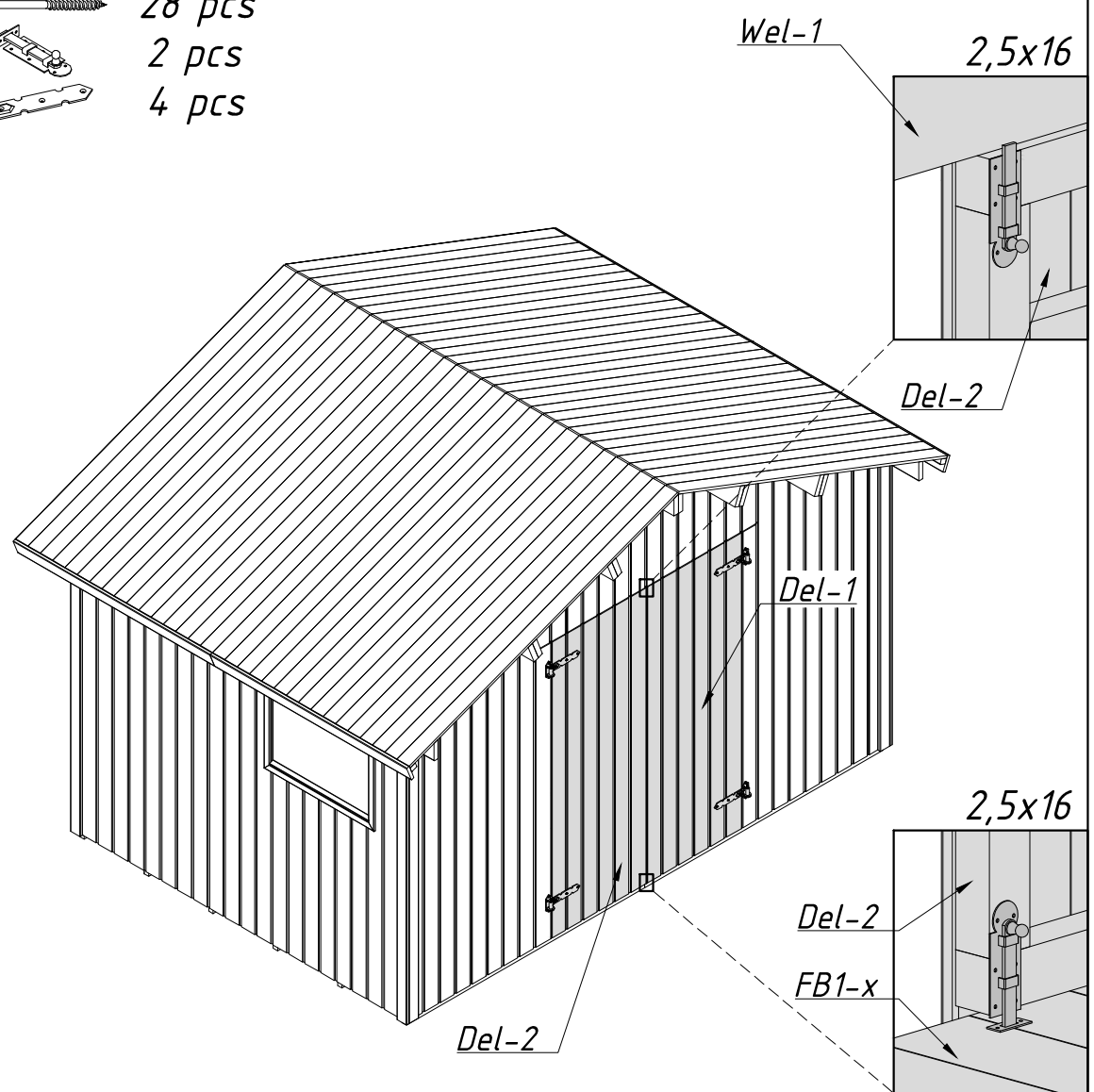
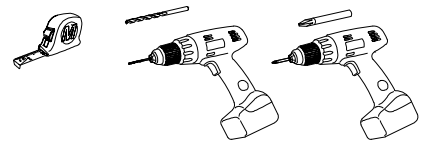

- Del-1 1 pcs
- Del-2 1 pcs
- 2,5x16 14 pcs
- 4,5x40 28 pcs
- 2 pcs
- 4 pcs

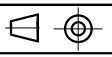
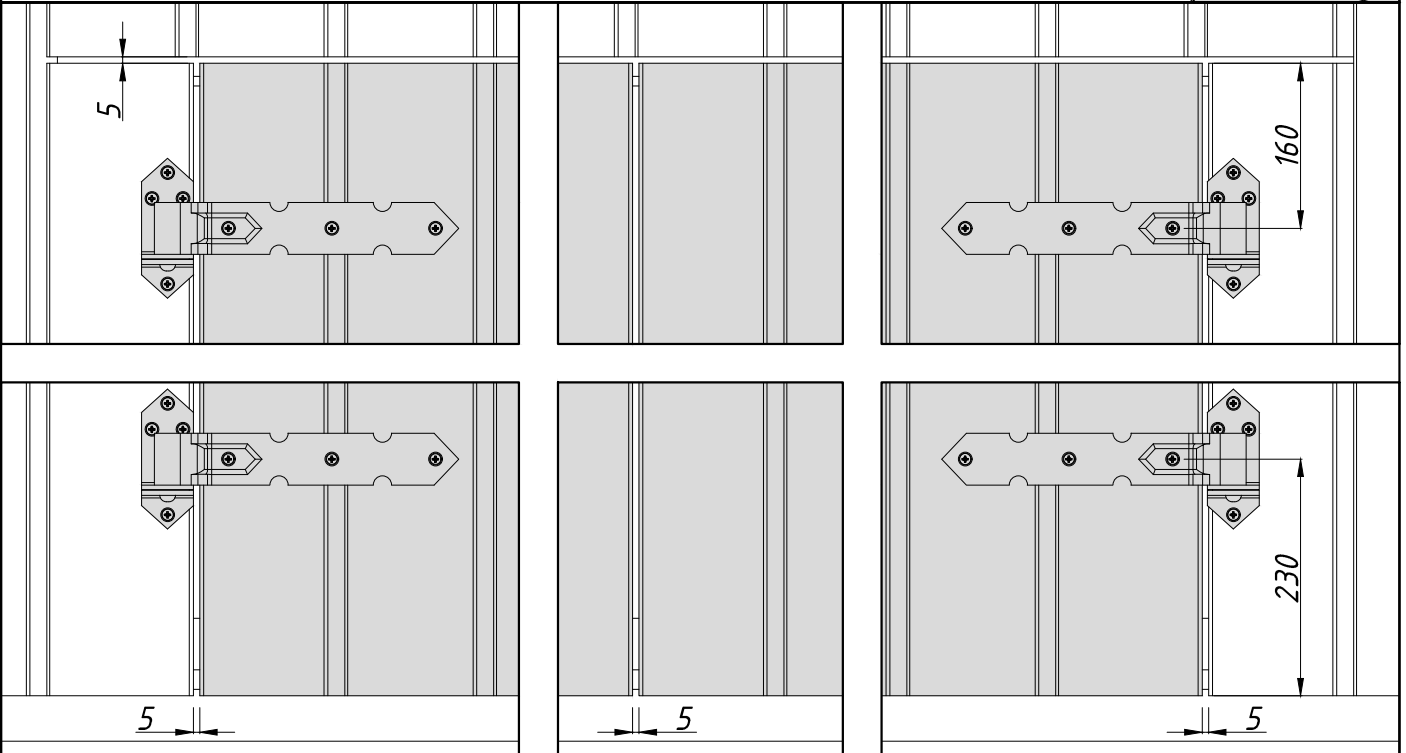

4,5x40

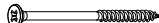

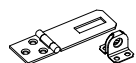
- Sla1* 2 pcs
- FaB3-1* 4 pcs
- WB1-1* 4 pcs
- 3,5x40*  46 pcs
- 4,5x40*  7 pcs
-  1 pcs

